

A modern hotel room with a bed, armchairs, and a window with curtains. The room features a curved ceiling with recessed lighting and a dark brown wall. The bed is covered with white linens and a dark grey blanket. There are two light-colored armchairs and a glass coffee table near the window. The window has white sheer curtains and dark heavy curtains. A small teal square artwork is on the wall.

hotel&office

2020

VITRIFRIGO
COOL AND BEYOND

FREEZE YOUR MOMENTS



RENDI UNICO OGNI MOMENTO SPECIALE

INNOVAZIONE, DESIGN E ECOSOSTENIBILITÀ:

è la Mission di Vitrifrigo e fa parte di una più ampia strategia aziendale volta al profondo rispetto degli obblighi ambientali.

Abbiamo dato vita ad una vera e propria politica per continuare il nostro impegno a operare come società responsabile, coinvolgendo direttamente o indirettamente tutti gli aspetti delle attività aziendali: progettazione, ingegneria, produzione, manutenzione dei prodotti o distribuzione delle loro parti.

In linea con questa politica, Vitrifrigo ha investito risorse multiple per rinnovare le serie dei prodotti integrando soluzioni a basso GWP e Gas Naturale.

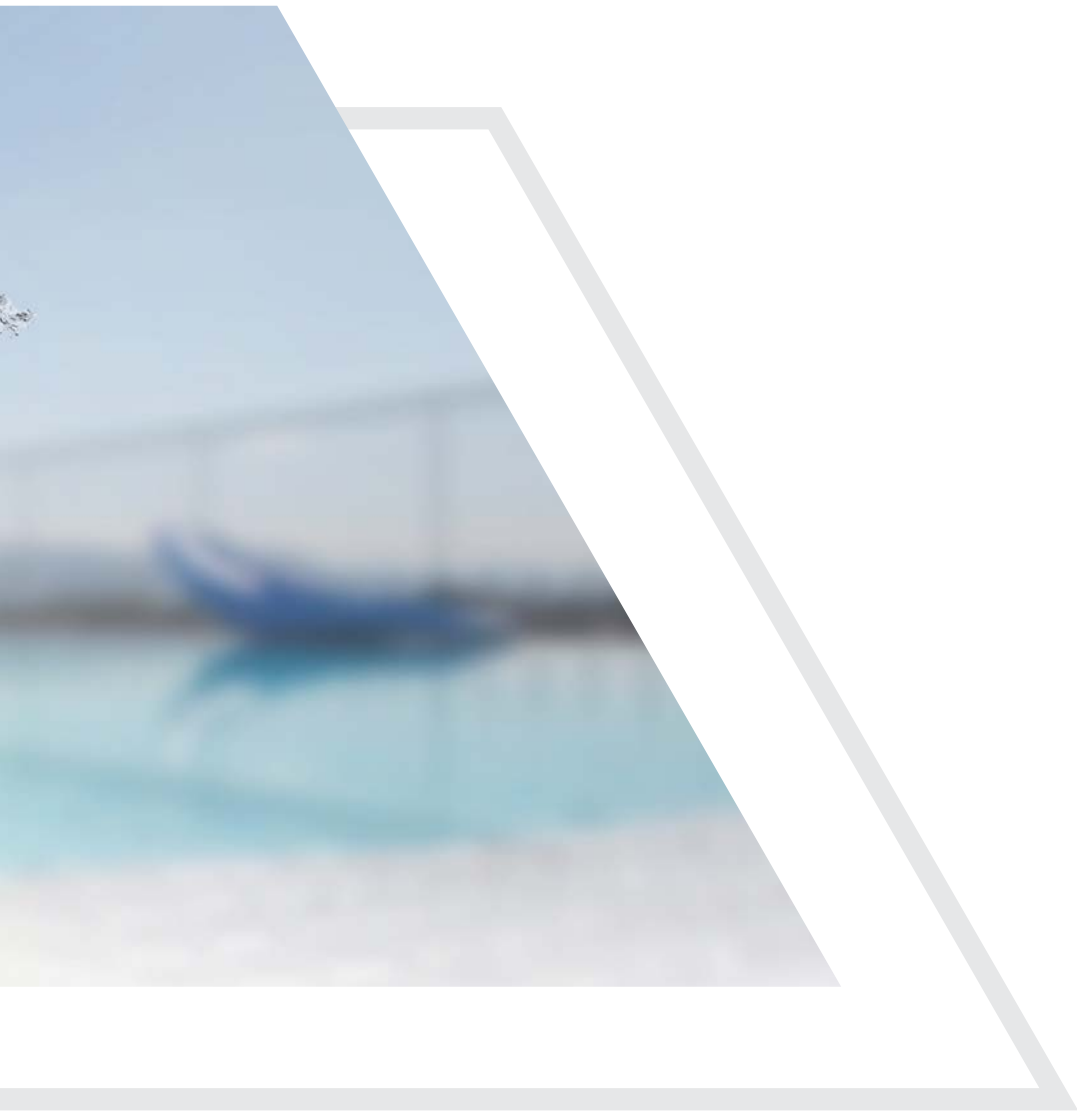

MAKE EVERY SPECIAL MOMENT UNIQUE

INNOVATION, DESIGN AND **ECO-SUSTAINABILITY**:

This is the fundamental core of Vitrifrigo and is part of a broader corporate strategy aimed at respecting environmental obligations.

We have developed a policy to continue our commitment to operate as a responsible company. This covers every aspect of the company's activities, whether directly or indirectly involved in the design, engineering, manufacturing, maintenance of our products, or distribution of their parts.

In line with this policy, Vitrifrigo has invested multiple resources to renew the ranges of products with low GWP and Natural Gas solutions.

MADE IN ITALY



Next



Minibar a compressore

Compressor minibars

6

Top Class



Minibar ad assorbimento

Absorption minibars

12

Elegant



Minibar ad assorbimento

Absorption minibars

20

Interior



Minibar a compressore

Compressor minibars

36

Glasses



Minibar a compressore con porta in vetro

Glass door compressor minibars

42

Light



Minibar ad assorbimento

Absorption minibars

28

Light D



Minibar termoelettrici a cassetto

Drawer thermoelectric minibars

32

Wine cellar



Cantinette

Wine cellars

34

Top Loading



Frigo a pozzetto a compressore

Top loading compressor refrigerators

44

Safe



Casseforti

Safes

46

Hair



Asciugacapelli

Hairdryers

48

NEXT: minibar a compressore

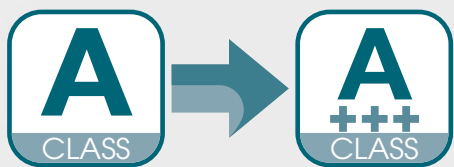

NEXT: minibar a compressore

Progettata per esprimere il massimo della versatilità, la serie NEXT rappresenta la soluzione ideale per la personalizzazione della camera.

Disponibile con anta personalizzabile (P) o con anta in vetro specchiato (V), per raggiungere il massimo grado di finitura estetica.

Una continua evoluzione per raggiungere il massimo della funzionalità con il minimo consumo (test di consumo energetico effettuati a 25°C secondo la norma EN153).

SERIE DM: un nuovo gas refrigerante naturale, un nuovo compressore, ma soprattutto consumi eccezionalmente bassi, abbinati ad una silenziosità sorprendente per un frigo a compressore.

Dotati di termostato meccanico, i minibar NEXT serie DM permettono una facile personalizzazione della temperatura.



Serie P - P series



Serie V - V series



**REFRIGERANTE
A BASSO GWP**

LOW GWP
REFRIGERANT

NEXT: compressor minibars

Designed to provide the utmost versatility, the NEXT range is the ideal solution for customising a room.

Available with customised (P) or mirrored glass door (V), to provide the perfect aesthetic finish.

Continued evolution to achieve the maximum practical use with minimum power consumption (power consumption tests carried out at 25°C in compliance with the standard EN153).

DM SERIES: a new compressor, a new natural coolant gas but above all, exceptionally low power consumption together with surprisingly silent operation for a compressor refrigerator.

Equipped with a mechanical thermostat, the DM models allow to get and easier temperature customization.

NEXT: minibar a compressore



GAS NATURALE Consumi ai minimi livelli con emissioni di CO2 trascurabili

Vitrifrigo usa un gas refrigerante con GWP (Global Warming Potential - il potenziale contributo all'effetto serra) inferiore di oltre 430 volte a quello dei gas normalmente utilizzati nella produzione dei frigoriferi per il settore alberghiero.

Gas naturale e alta tecnologia sono sinonimo di risparmio energetico e quindi anche di risparmio economico: i nuovi frigoriferi VITRIFRIGO hanno un consumo fino a 7 volte inferiore rispetto ai frigoriferi attualmente in commercio.

NATURAL GAS Minimum level consumption and negligible CO2 emissions

Vitrifrigo uses a refrigerant gas with GWP (Global Warming Potential - the potential contribution to the greenhouse effect) more than 430 times lower than those normally used to make refrigerators for the hotel industry.

High-tech and natural gas are synonymous with energy savings and therefore, with saving money: the new VITRIFRIGO refrigerators consume up to 7 times less than the refrigerators currently available on the marketplace.

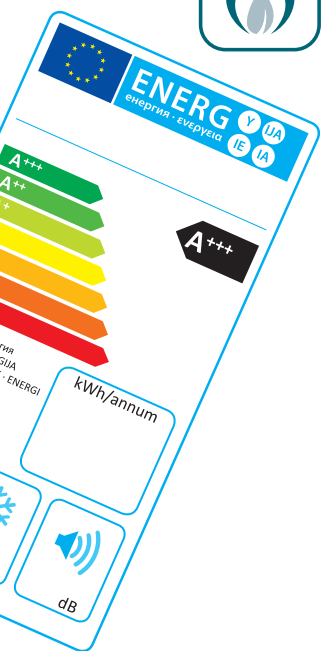

INNOVATIVO SISTEMA DI ILLUMINAZIONE POTENZIATA A LED

AN INNOVATIVE LED LIGHTING SYSTEM

STANDARD



BALCONCINO PORTA BEVANDE PER BOTTIGLIE DA 1,5 LITRI

DRINKS SHELF SUITABLE FOR 1,5-LITRES BOTTLES

STANDARD



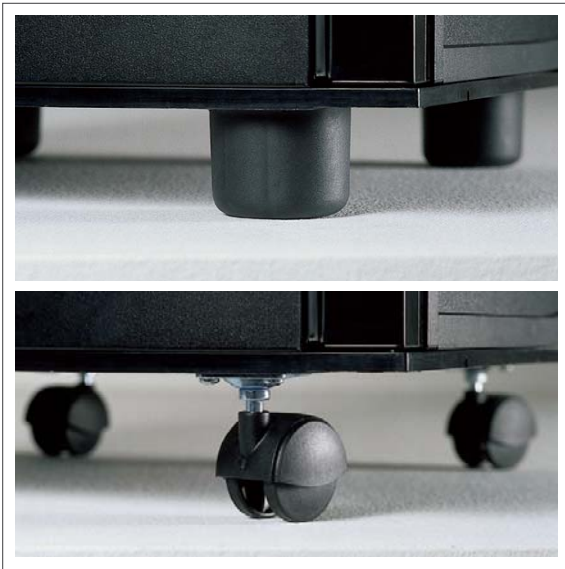

**DISPONIBILI CON PIEDI DA
CM 4,5 O RUOTE DA CM 6**

**AVAILABLE WITH 4.5 CM
FEET OR 6 CM WHEELS**

OPTIONAL

Eccetto - Except
C330 V NEXT DM - C420 V NEXT DM



CERNIERA A TRAINO

SLIDING HINGE

OPTIONAL

Eccetto - Except
C330 V NEXT DM - C420 V NEXT DM



**AMPIA GAMMA DI COLORI PER
IL PANNELLO FRONTALE**

**FRONT PANEL WIDE COLOUR
RANGE**

STANDARD

C330 P NEXT DM C420 P NEXT DM

C330 P NEXT DM

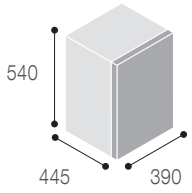

Capacità
Volume
33 lt.

Peso netto
Net weight
17 kg.

C420 P NEXT DM

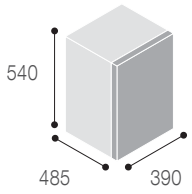

Capacità
Volume
40 lt.

Peso netto
Net weight
18 kg.



Alimentazione
Power supply
230Vac 50/60Hz



C330 P NEXT DM



**REFRIGERANTE
A BASSO GWP**

LOW GWP
REFRIGERANT



SILENT Rumore appena percettibile
fino a max 1 metro di distanza

Noise is barely perceived up to a
maximum of 1 meter away



FAST Alta velocità di abbattimento
temperatura

High-speed cooling



EASY Termostato meccanico

Mechanical thermostat



C420 P NEXT DM

C330 V NEXT DM C420 V NEXT DM



C330 V NEXT DM



**REFRIGERANTE
A BASSO GWP**
LOW GWP
REFRIGERANT

SILENT

Rumore appena percettibile
fino a max 1 metro di distanza



Noise is barely perceived up to a
maximum of 1 meter away

FAST

Alta velocità di abbattimento
temperatura



High-speed cooling

EASY

Termostato meccanico



Mechanical thermostat

C330 V NEXT DM

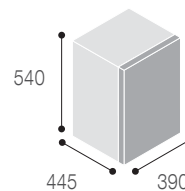

Capacità
Volume
33 lt.

Peso netto
Net weight
21 kg.

C420 V NEXT DM

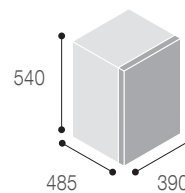

Capacità
Volume
40 lt.

Peso netto
Net weight
22 kg.



Alimentazione
Power supply

230Vac 50/60Hz



C420 V NEXT DM

TOP CLASS: minibar ad assorbimento



TOP CLASS: minibar ad assorbimento

Una gamma completa di minibar, dal design elegante, capaci di garantire il silenzio più assoluto unitamente a consumi estremamente ridotti, grazie alla nuova tecnologia LPC (Low Power Consumption): un sofisticato sistema elettronico per l'ottimizzazione delle funzioni del frigorifero, abbinato ad un gruppo ad assorbimento di nuova generazione.

È disponibile in tre serie differenti, per soddisfare ogni esigenza di stile e di posizionamento.

SERIE P: la possibilità di avere la porta pannellabile in soluzioni cromatiche differenti permette la realizzazione del coordinato di arredo.

SERIE L: particolarmente indicata per le soluzioni ad incasso può essere utilizzata con o senza cerniera a traino.

SERIE V: grazie alla sua anta in vetro a piena trasparenza, raggiunge un effetto estetico davvero piacevole, adatto ad invogliare la consumazione.



Serie P - P series



Serie L - L series



Serie V - V series

TOP CLASS: absorption minibars

A full range of minibars with elegant design and able to guarantee maximum silence together with extremely reduced power consumption, thanks to new LPC (Low Power Consumption) technology: a sophisticated electronic system to optimise refrigerator operation, combined with a next-generation absorption unit. Available in three different ranges to meet all style and installation needs.

P SERIES: the possibility to have a panel door in different colour solutions for coordination with different surroundings.

L SERIES: especially recommended for built-in solutions. Available with or without sliding hinge.

V SERIES: a fully transparent glass door and new LED lighting inside create a truly eye-catching style effect that will also encourage consumption.

TOP CLASS: minibar ad assorbimento

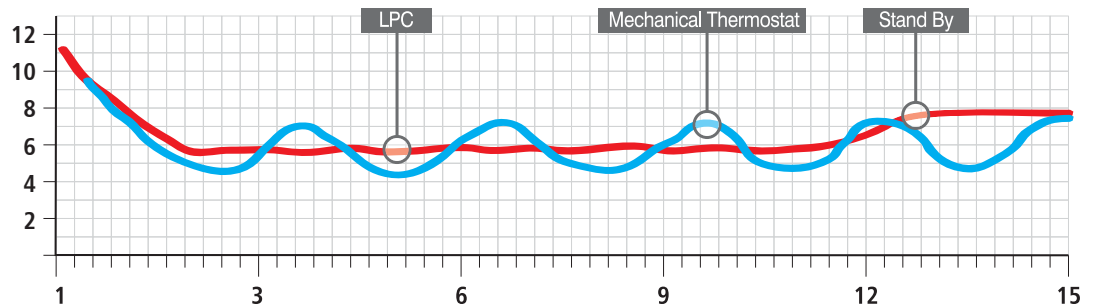

SISTEMA LPC

Nuovo Sistema LPC elettronico sviluppato per ottimizzare le funzioni del frigorifero e abbassare sensibilmente i consumi.

Nuovo impianto ad assorbimento di ultima generazione estremamente efficiente consente una forte riduzione del fabbisogno energetico.

Funzione Stand By: in condizioni di inutilizzo prolungato del frigo, riduce ulteriormente i consumi, regolando automaticamente sul minimo la temperatura del frigo stesso.

Nuovo termostato con coprisonda: la funzione termostato è affidata alla scheda di controllo per il risparmio energetico.

LPC SYSTEM

New electronic LPC system developed to optimise refrigerator functions and to significantly reduce energy consumption.

Next-generation absorption system: extremely efficient, this system allows a significant reduction in energy requirements.

Standby function: in cases of prolonged disuse of the refrigerator, further reduces energy consumption by automatically setting the temperature of the refrigerator to minimum.

New thermostat with probe cover: the thermostat is operated from a board for controlling energy saving.

INNOVATIVO SISTEMA DI ILLUMINAZIONE POTENZIATA A LED

AN INNOVATIVE LED LIGHTING SYSTEM

STANDARD



BALCONCINO PORTA BEVANDE PER BOTTIGLIE DA 1,5 LITRI

DRINKS SHELF SUITABLE FOR 1,5-LITRES BOTTLES

STANDARD



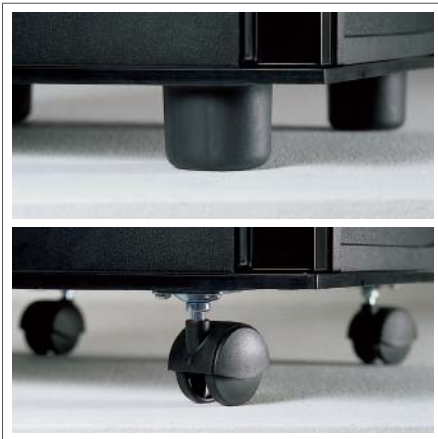

**DISPONIBILI CON PIEDI DA
CM 4,5 O RUOTE DA CM 6**

**AVAILABLE WITH 4.5 CM FEET
OR 6 CM WHEELS**

OPTIONAL

Eccetto - Except
C330 V TOP CLASS - C420 V TOP CLASS



CERNIERA A TRAINO

SLIDING HINGE

STANDARD

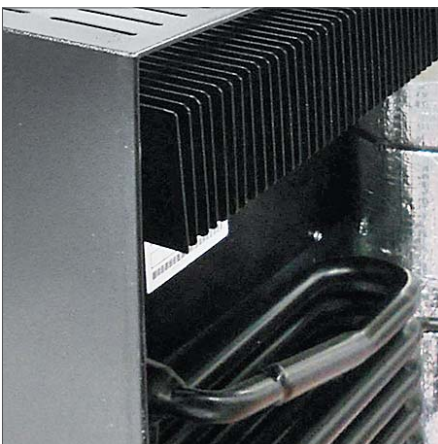

CARTER COPRIMOTORE

CASING

OPTIONAL



**CHIUSURA CON CHIAVE DI
SICUREZZA**

SAFETY LOCK

OPTIONAL



MANIGLIA LATERALE

SIDE HANDLE

OPTIONAL

C330 P TOP CLASS

C330 P TOP CLASS

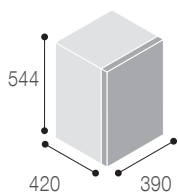

Capacità
Volume
33 lt.

Peso netto
Net weight
14 kg.

Alimentazione
Power supply
230Vac 50/60Hz



Colore pannello: nero
Panel colour: black

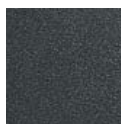

Standard

Pannello porta sostituibile
Replaceable door panel

SERIE TOP CLASS P

Trova la sua collocazione ideale all'interno di mobili da incasso, dove il frontale del frigo sia visibile: grazie all'elegante linea dello chassis e alla porta pannellabile si ha la possibilità di creare un arredamento coordinato all'interno della camera.



C330 P TOP CLASS

TOP CLASS P SERIES

Ideal for installation inside a built-in unit where the front of the refrigerator is visible: thanks to the elegant line of the chassis and the panel door, it is possible to create a look that blends perfectly with the style of the room.

C420 P TOP CLASS

C420 P TOP CLASS

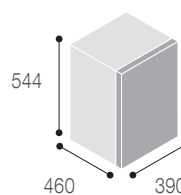

Capacità
Volume
40 lt.

Peso netto
Net weight
15 kg.

Alimentazione
Power supply
230Vac 50/60Hz



C420 P TOP CLASS

C330 L TOP CLASS C420 L TOP CLASS

C330 L TOP CLASS

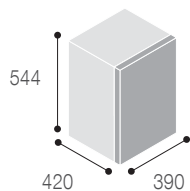

Capacità
Volume
33 lt.

Peso netto
Net weight
16 kg.

C420 L TOP CLASS

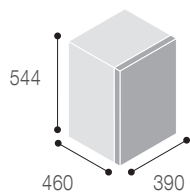

Capacità
Volume
40 lt.

Peso netto
Net weight
17 kg.

Alimentazione
Power supply
230Vac 50/60Hz



C330 L TOP CLASS

Colore pannello
Panel colour

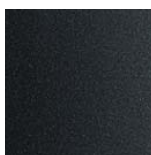

nero
black



rovere
oak



noce
walnut



C420 L TOP CLASS

TOP CLASS: absorption minibars

C330 V TOP CLASS C420 V TOP CLASS

C330 V TOP CLASS

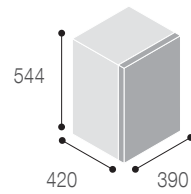

Capacità
Volume
33 lt.

Peso netto
Net weight
16 kg.

C420 V TOP CLASS

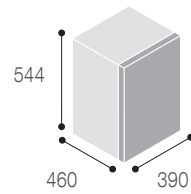

Capacità
Volume
40 lt.

Peso netto
Net weight
17 kg.

Alimentazione
Power supply

230Vac 50/60Hz



C330 V TOP CLASS



C420 V TOP CLASS

ELEGANT: minibar ad assorbimento



ELEGANT: minibar ad assorbimento

Una gamma completa di minibar, dal design elegante, capaci di garantire il silenzio più assoluto unitamente a consumi estremamente ridotti, grazie alla nuova tecnologia LPC (Low Power Consumption): un sofisticato sistema elettronico per l'ottimizzazione delle funzioni del frigorifero, abbinato ad un gruppo ad assorbimento di nuova generazione.

È disponibile in quattro serie differenti, per soddisfare ogni esigenza di stile e di posizionamento.

SERIE SL: indicata per le soluzioni ad incasso può essere utilizzata con o senza cerniera a traino.

SERIE S: la porta pannellabile in soluzioni cromatiche differenti permette la realizzazione del coordinato di arredo.

SERIE SV: grazie alla sua anta in vetro a piena trasparenza, raggiunge un effetto estetico davvero piacevole, adatto ad invogliare la consumazione.

SERIE BAR: costituita dal frigobar completo di mobile e vano non refrigerato per snack o cassaforte.



Serie SL - SL series



Serie S - S series



Serie SV - SV series



Serie BAR - BAR series

ELEGANT: absorption minibars

A full range of minibars with elegant design and able to guarantee maximum silence together with extremely reduced power consumption, thanks to new LPC (Low Power Consumption) technology: a sophisticated electronic system to optimise refrigerator operation, combined with a next-generation absorption unit. Available in four different ranges to meet all style and installation needs.

SL SERIES: recommended for built in solutions and available with or without sliding hinge.

S SERIES: the possibility to have a panel door in different colour solutions for coordination with different surroundings.

SV SERIES: a fully transparent glass door creates a truly eye-catching style effect that will also encourage consumption.

BAR SERIES: minibar complete with wooden cabinet and compartment for snacks or room safe.

ELEGANT: minibar ad assorbimento

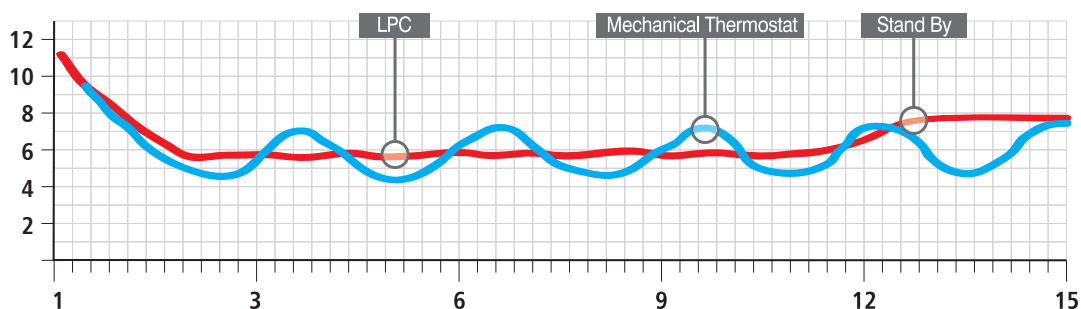

SISTEMA LPC

Nuovo Sistema LPC elettronico sviluppato per ottimizzare le funzioni del frigorifero e abbassare sensibilmente i consumi.

Nuovo impianto ad assorbimento di ultima generazione estremamente efficiente consente una forte riduzione del fabbisogno energetico.

Funzione Stand By: in condizioni di inutilizzo prolungato del frigo, riduce ulteriormente i consumi, regolando automaticamente sul minimo la temperatura del frigo stesso.

Nuovo termostato con coprisonda: la funzione termostato è affidata alla scheda di controllo per il risparmio energetico.

LPC SYSTEM

New electronic LPC system developed to optimise refrigerator functions and to significantly reduce energy consumption.

Next-generation absorption system: extremely efficient, this system allows a significant reduction in energy requirements.

Standby function: in cases of prolonged disuse of the refrigerator, further reduces energy consumption by automatically setting the temperature of the refrigerator to minimum.

New thermostat with probe cover: the thermostat is operated from a board for controlling energy saving.

INNOVATIVO SISTEMA DI ILLUMINAZIONE POTENZIATA A LED

AN INNOVATIVE LED LIGHTING SYSTEM

STANDARD

Eccetto - Except
C250SV - C600SV



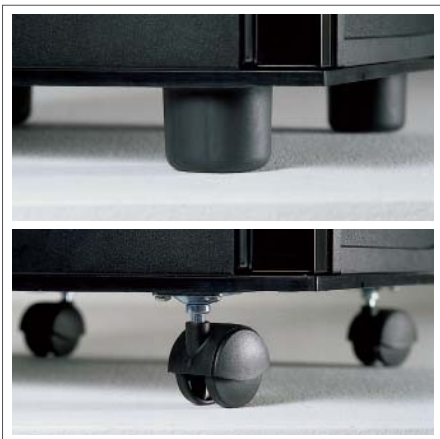

**DISPONIBILI CON PIEDI DA
CM 4,5 O RUOTE DA CM 6**

**AVAILABLE WITH 4.5 CM FEET
OR 6 CM WHEELS**

OPTIONAL
Eccetto / Except
C250SV
C600SV



**CERNIERA A TRAINO
SLIDING HINGE**

STANDARD



**CHIUSURA CON CHIAVE DI
SICUREZZA**

SAFETY LOCK

OPTIONAL
Eccetto / Except
C250SV
C600SV



MANIGLIA LATERALE

SIDE HANDLE

OPTIONAL
Eccetto / Except
C250SV
C600SV

C600 SL

C600 SL

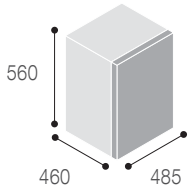

Capacità
Volume
55 lt.

Peso netto
Net weight
19 kg.

Alimentazione
Power supply
230Vac 50/60Hz



Colore pannello
Panel colour



nero
black



rovere
oak



noce
walnut



C600 SL

C250 S C600 S



C250 S

C250 S

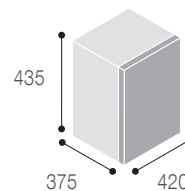

Capacità
Volume
25 lt.

Peso netto
Net weight
12 kg.

C600 S

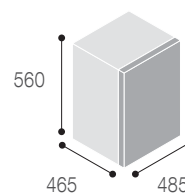

Capacità
Volume
55 lt.

Peso netto
Net weight
18 kg.

Alimentazione
Power supply

230Vac 50/60Hz



Colore pannello: nero
Panel colour: black

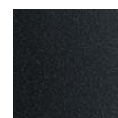

Pannello porta
sostituibile

Replaceable door
panel



C600 S

C250 SV C600 SV

C250 SV

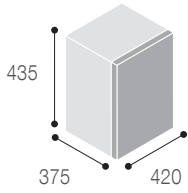

Capacità
Volume
25 lt.

Peso netto
Net weight
13 kg.

C600 SV

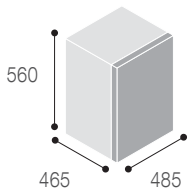

Capacità
Volume
55 lt.

Peso netto
Net weight
19 kg.

Alimentazione
Power supply
230Vac 50/60Hz



C250 SV
Luce interna LED non presente
No internal LED light



C600 SV
Luce interna LED non presente
No internal LED light

C420 BAR

SERIE ELEGANT BAR

La serie Bar è costituita dal frigobar completo di mobiletto e vano non refrigerato per snack o cassaforte (optional), serratura a chiave, ruote ed apribottiglie.

ELEGANT BAR SERIES

The Bar series is comprised of minibars complete with cabinet and compartment for snacks or safe (optional), lock and key, castors and bottle opener.

C420 Bar

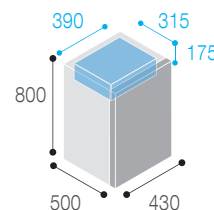

Capacità
Volume
40 lt.

Peso netto
Net weight
30 kg.

Alimentazione
Power supply
230Vac 50/60Hz



C420 Bar

Colore pannello
Panel colour

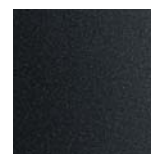

nero
black



noce
walnut

LIGHT: minibar ad assorbimento



LIGHT: minibar ad assorbimento

La serie Light si compone di una gamma di minibar dotati di tecnologia ad assorbimento in grado di offrire il miglior rapporto in termini economico-prestazionali. Prodotti secondo le rigorose specifiche tecniche Vitrifrigo, vengono proposti in duplice versione:

SERIE HC: indicata per le soluzioni di libero posizionamento, può essere utilizzata ad incasso con o senza cerniera a traino.

SERIE HCV: grazie alla sua anta in vetro a piena trasparenza ed alla nuova illuminazione interna a Led, raggiunge un effetto estetico davvero piacevole, adatto ad invogliare la consumazione.



Serie HC - HC series



Serie HCV - HCV series



**ILLUMINAZIONE A LED
LED LIGHTING SYSTEM**

STANDARD



**CERNIERA A TRAINO
SLIDING HINGE**

STANDARD

LIGHT: absorption minibars

The Light range is a line of absorption technology minibars able to offer the best possible relationships in terms of cost-efficiency and performance. Made following the stringent technical specifications of Vitrifrigo, they are available in two versions:

SERIE HC: Recommended for free-standing installation, but also for built-in installation, with or without sliding hinge.

SERIE HCV: a fully transparent glass door and new LED lighting inside create a truly eye-catching style effect that will also encourage consumption.

HC25 - HC30 - HC40

HC25

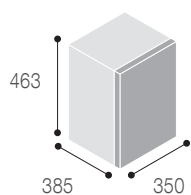

Capacità
Volume
25 lt.

Peso netto
Net weight
12 kg.

HC30

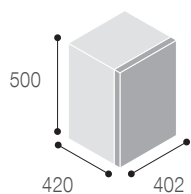

Capacità
Volume
30 lt.

Peso netto
Net weight
16,5 kg.

HC40

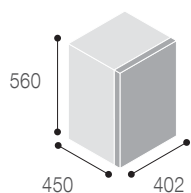

Capacità
Volume
40 lt.

Peso netto
Net weight
18,5 kg.

Alimentazione
Power supply

230Vac 50/60Hz



HC25



HC40



HC30

HC30 V - HC40 V



HC30 V

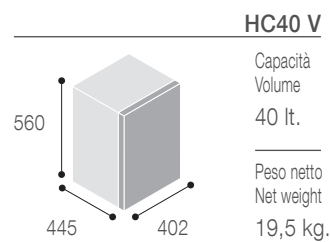
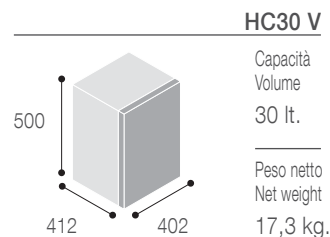

Alimentazione
Power supply 230Vac 50/60Hz



HC40 V

LIGHT D: minibar termoelettrici a cassetto



LIGHT D: minibar termoelettrici a cassetto

Il minibar a cassetto termoelettrico TD45 offre un elevato grado di comfort e di funzionalità.

La tecnologia a celle di Peltier ha raggiunto oggi un elevato livello di affidabilità ed economicità. Inoltre, tale tecnologia garantisce una notevole silenziosità e bassi consumi (classe A).

Il modello TD45 offre il massimo utilizzo dello spazio disponibile, grazie ad un cassetto capiente, dotato di alloggiamento per bottiglie e lattine. Il minibar è completo di illuminazione interna a LED e di pannello porta nero specchiato che si inserisce elegantemente in qualsiasi tipologia di arredo.

LIGHT D: drawer thermoelectric minibars

The stylish TD45 drawer minibar gives your guests easy access to perfectly chilled drinks.

Class A energy rated, the new Peltier cell technology delivers excellent reliability and power economy and is silent in operation. The TD45 has excellent storage within the drawer able to store both bottles and cans.

There is an internal LED light to display the products and the elegant mirrored black panel door fits beautifully into any type of furniture.

TD45

Capacità totale - Total volume	40 lt.
Peso netto - Net weight	15 kg.
Alimentazione - Power supply	230 Vac 50/60 Hz

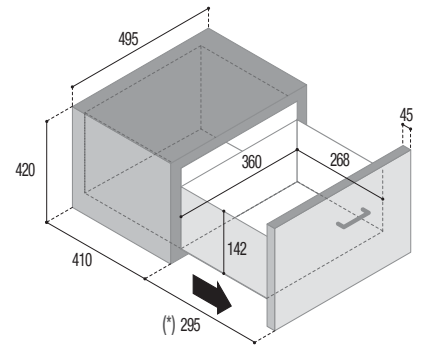

(*) Estensione massima del cassetto - Max drawer extension



CANTINETTE



CANTINETTE

I modelli di cantinette disponibili hanno capacità di 10, 18 e 32 bottiglie, anta con vetro oscurato (protezione raggi UV) e finitura in acciaio inox spazzolato.

Ideali per conservare le bottiglie di vino anche per lunghi periodi, hanno la regolazione della temperatura mediante termostato digitale (+4°C +18°C).

WINE CELLARS

The available wine cellar models have a capacity of 10, 18 or 32 bottles, with darkened glass (protection against UV rays) and brushed stainless steel finish. Ideal for storing bottles of wine even for long periods.

The temperature settings are adjusted by digital thermostat (+4°C +18°C).

DCW95

Capacità totale - Total volume	95 lt.
Peso netto - Net weight	26 kg.
Alimentazione - Power supply	230 Vac

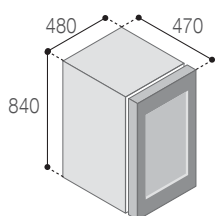

Porta non reversibile
Non-reversible door

 **N. 32**
H max: 315 mm.
Ø max: 76 mm.



DCW62

Capacità totale - Total volume	62 lt.
Peso netto - Net weight	21 kg.
Alimentazione - Power supply	230 Vac

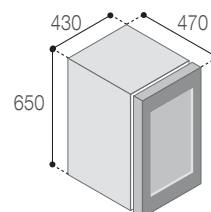

Porta non reversibile
Non-reversible door

 **N. 18**
H max: 315 mm.
Ø max: 76 mm.



DCW46

Capacità totale - Total volume	46 lt.
Peso netto - Net weight	18 kg.
Alimentazione - Power supply	230 Vac

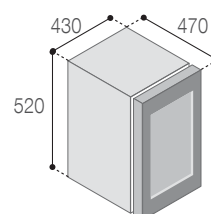

Porta non reversibile
Non-reversible door

 **N. 10**
H max: 315 mm.
Ø max: 76 mm.



OFFICE: minibar a compressore



**REFRIGERANTE
A BASSO GWP**

LOW GWP
REFRIGERANT



OFFICE: minibar a compressore

Una gamma completa di minibar a compressore per arricchire uffici, sale conferenze e luoghi di riunione con frigoriferi di livello qualitativo elevato, ampiamente personalizzabili, posizionabili sia ad incasso totale che in versione a libero posizionamento, proposti in triplice versione:

INTERIOR: un'ampia gamma di minibar da 39 a 115 lt, disponibili sia in versione a libero posizionamento, che in modalità ad incasso totale con o senza cerniera a traino.

GLASS: una serie di vetrinette con anta a piena trasparenza che raggiungono un effetto estetico davvero piacevole, adatto ad invogliare la consumazione.

TOP LOADING frigorifero a pozzetto, pronto per l'incasso all'interno di un qualsiasi vano.

OFFICE: compressor minibars

A full range of compressor-operated minibars for offices, conference rooms or meeting rooms. Top-quality refrigerators with wide range for customisation and able to be installed either built in or free standing. Available in three versions:

INTERIOR: volume from 39 to 115 litres, for free-standing or built-in installation with or without sliding hinge.

GLASS: a range of showcase fridges with fully transparent glass door to create a truly eye-catching style effect that will also encourage consumption.

TOP LOADING: top-loading refrigerator for built-in installation in any compartment.

Totally relaxed use, always within arm's reach.



Serie Interior
Interior series



Serie Glass
Glass series



Serie Top Loading
Top Loading series



INNOVATIVO SISTEMA DI ILLUMINAZIONE A LED

AN INNOVATIVE LED LIGHTING SYSTEM

STANDARD
Eccetto modelli serie PV
Except for PV series models



BALCONCINO PORTA BEVANDE PER BOTTIGLIE DA 1,5 LITRI

DRINKS SHELF SUITABLE FOR 1,5-LITRES BOTTLES

STANDARD



CERNIERA A TRAINO

SLIDING HINGE

OPTIONAL
Eccetto modelli serie PV
Except for PV series

C39i

C39i

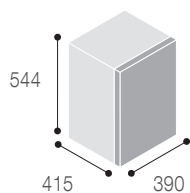

Capacità tot.
Tot. volume
39 lt.

Vano freezer
Freezer comp.
3,6 lt.

Peso netto
Net weight
18 kg.

Alimentazione
Power supply

230 Vac



**REFRIGERANTE
A BASSO GWP**

LOW GWP
REFRIGERANT



C39i



C50i C60i



C50i

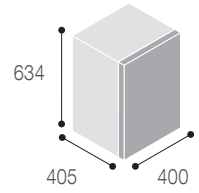

C50i

Capacità tot.
Tot. volume
50 lt.

Vano freezer
Freezer comp.
3,6 lt.

Peso netto
Net weight
18 kg.

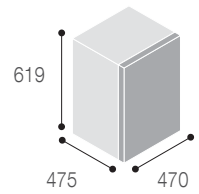

C60i

Capacità tot.
Tot. volume
60 lt.

Vano freezer
Freezer comp.
10,2 lt.

Peso netto
Net weight
22 kg.

Alimentazione
Power supply

230 Vac



**REFRIGERANTE
A BASSO GWP**

LOW GWP
REFRIGERANT



C60i



C85i C115i

C85i

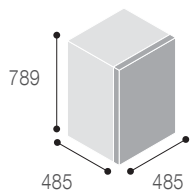

Capacità tot.
Tot. volume
85 lt.

Vano freezer
Freezer comp.
12,8 lt.

Peso netto
Net weight
26 kg.

C115i

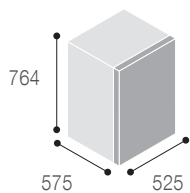

Capacità tot.
Tot. volume
115 lt.

Vano freezer
Freezer comp.
17,1 lt.

Peso netto
Net weight
28 kg.

Alimentazione
Power supply

230 Vac



**REFRIGERANTE
A BASSO GWP**

LOW GWP
REFRIGERANT



C85i



C115i



C115i bianco/white



LT 45 BAR LT 75 BAR



LT45 BAR



LT45 BAR bianco/white

LT45 BAR

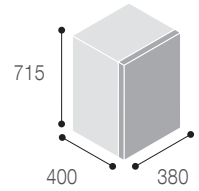

Porta non reversibile
Non-reversible door

Capacità tot.
Tot. volume
45 lt.

Vano freezer
Freezer comp.
3,6 lt.

Peso netto
Net weight
20 kg.

LT75 BAR

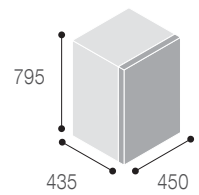

Porta non reversibile
Non-reversible door

Capacità tot.
Tot. volume
75 lt.

Vano freezer
Freezer comp.
10,2 lt.

Peso netto
Net weight
24 kg.

Alimentazione
Power supply

230 Vac



**REFRIGERANTE
A BASSO GWP**

LOW GWP
REFRIGERANT



LT75 BAR



LT75 BAR bianco/white

C39 PV C60 PV C115 PV

C39 PV

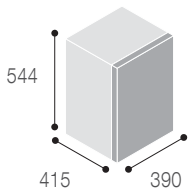

Capacità
Volume
39 lt.

Peso netto
Net weight
20 kg.

C60 PV

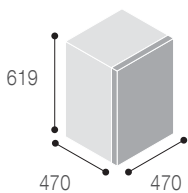

Capacità
Volume
60 lt.

Peso netto
Net weight
24 kg.

C115 PV

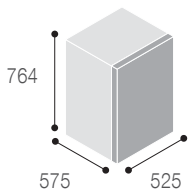

Capacità
Volume
115 lt.

Peso netto
Net weight
34 kg.

Alimentazione
Power supply
230 Vac



**REFRIGERANTE
A BASSO GWP**
LOW GWP
REFRIGERANT



C39 PV
Luce interna LED non presente
No internal LED light



C60 PV
Luce interna LED non presente
No internal LED light



C115 PV
Luce interna LED non presente
No internal LED light

LT 45 PV LT 75 PV



LT45 PV
Luce interna LED non presente
No internal LED light



LT75 PV
Luce interna LED non presente
No internal LED light

LT45 PV

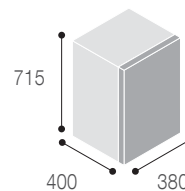

Capacità
Volume
45 lt.

Peso netto
Net weight
24 kg.

Porta non reversibile
Non-reversible door

LT75 PV

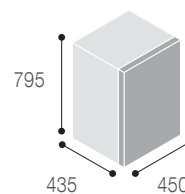

Capacità
Volume
75 lt.

Peso netto
Net weight
28 kg.

Porta non reversibile
Non-reversible door

Alimentazione
Power supply

230 Vac



**REFRIGERANTE
A BASSO GWP**

LOW GWP
REFRIGERANT

OFFICE: minibar a compressore

OFFICE: compressor minibars

TL40 ip

TL 40 ip

Capacità - Volume 40 lt.

Peso netto - Net weight 10 kg.

Alimentazione
Power supply 230 Vac

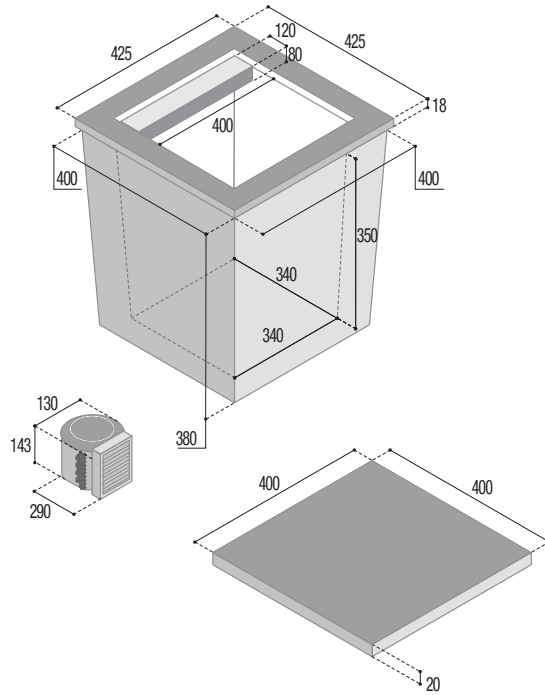

Coperchio con finitura in plastica gofrata
Lid with embossed plastic finish

Luce interna LED non presente
No internal LED light



SERIE TOP LOADING

Il frigorifero a pozzetto LT40 ip, grazie al facile accesso dall'alto a cibi e bevande, consente una flessibilità totale nell'installazione, sia per le dimensioni (contenute ma al tempo stesso capienti) che per quanto riguarda l'integrazione con l'arredamento esistente.

TOP LOADING SERIES

Thanks to easy access to foods and drinks from above, the LT40 ip top-loading refrigerator gives you total flexibility when it comes to installation, also because of its size (compact but roomy at the same time), and because it blends in easily with existing furnishings.



Griglia per l'aerazione
Ventilation grid

ESEMPI DI INSTALLAZIONE

Proponiamo alcuni esempi di installazione. Vitrifrigo, declina ogni responsabilità derivante da installazioni diverse da quelle dei disegni sopra riportati. Per informazioni più dettagliate vedi il manuale d'istruzione.

INSTALLATION EXAMPLES

We have shown here a few installation examples. Vitrifrigo refuses to accept any liability for installations that differ from those illustrated in the drawings above. For more detailed information, please see the instruction manual.

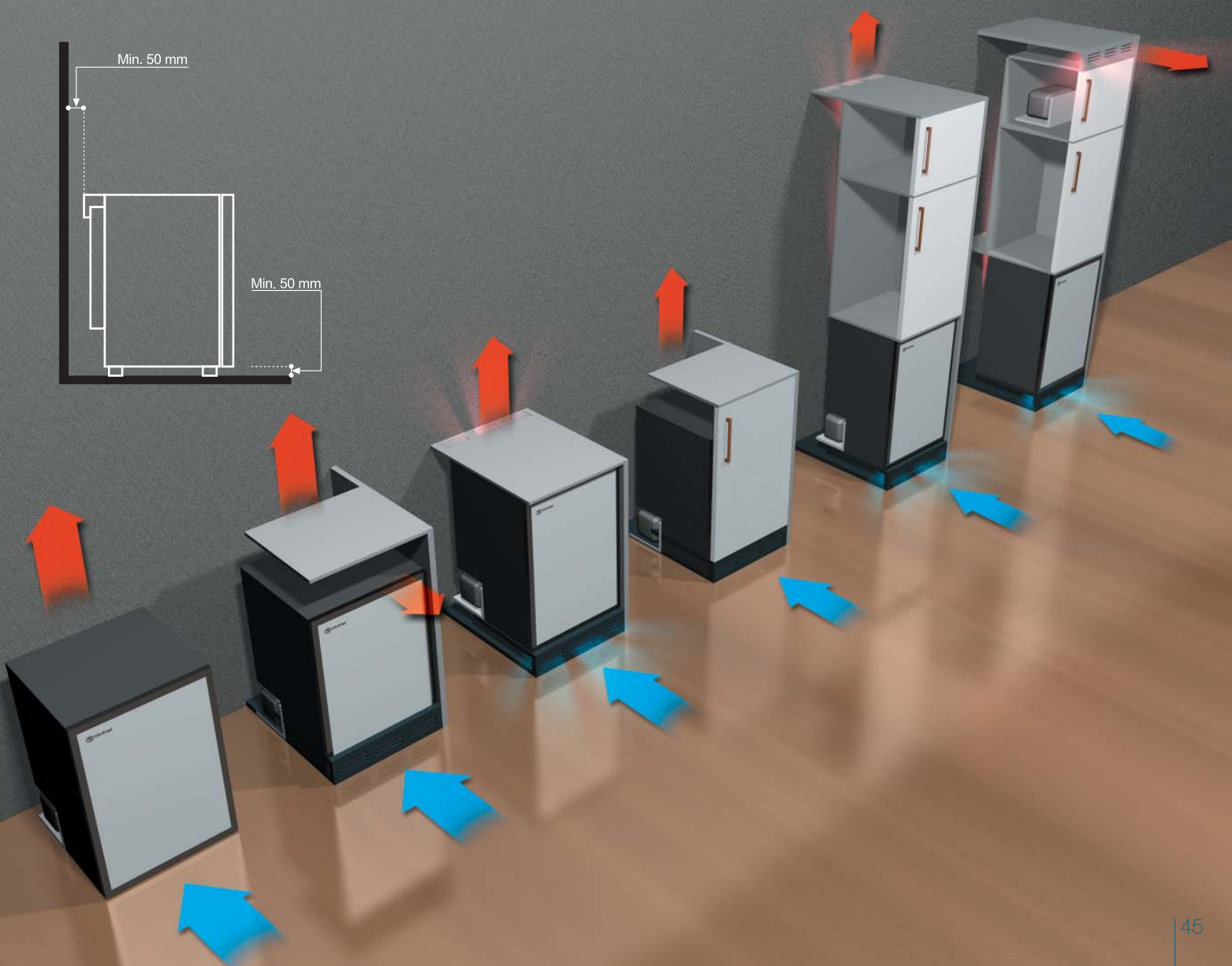
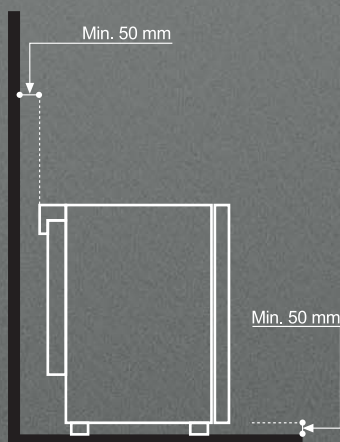



390 HE

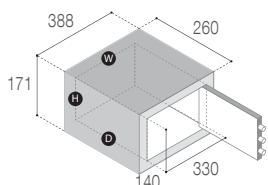

H: 155 W: 380 D: 240

Peso netto - Net weight **8 kg.**

Chiusura elettronica - Electronic lock
 Colore antracite - Anthracite coloured



VSAFE200

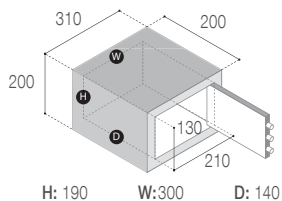

Peso netto - Net weight **4 kg.**

Luce interna a LED - Internal LED light
Password master-utente - Master-user password
Colore antracite - Anthracite coloured

VSAFE2050

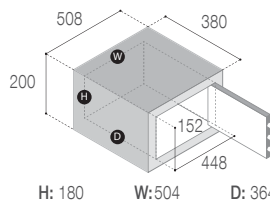

Peso netto - Net weight **15 kg.**

Chiusura motorizzata - Motorized lock
Display LED a 6 cifre - 6-digit LED display
Luce interna a LED - Internal LED light
Password master-utente - Master-user password
Colore antracite - Anthracite coloured

VSAFE2535

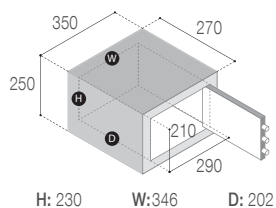

Peso netto - Net weight **11 kg.**

Chiusura motorizzata - Motorized lock
Display LED a 6 cifre - 6-digit LED display
Luce interna a LED - Internal LED light
Password master-utente - Master-user password
Colore antracite - Anthracite coloured

VSAFE1340 TOP

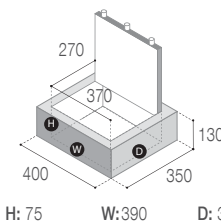

Peso netto - Net weight **12 kg.**

Display LED a 6 cifre - 6-digit LED display
Luce interna a LED - Internal LED light
Password master-utente - Master-user password
Colore antracite - Anthracite coloured

VSAFE2042

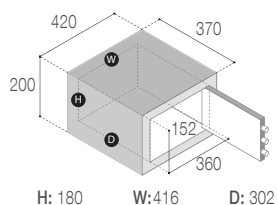

Peso netto - Net weight **13 kg.**

Chiusura motorizzata - Motorized lock
Display LED a 6 cifre - 6-digit LED display
Luce interna a LED - Internal LED light
Password master-utente - Master-user password
Colore antracite - Anthracite coloured

VSAFE1838 TOP

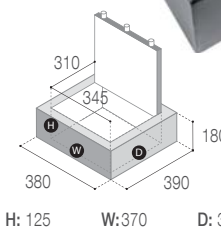

Peso netto - Net weight **13 kg.**

Display LED a 6 cifre - 6-digit LED display
Luce interna a LED - Internal LED light
Password master-utente - Master-user password
Colore antracite - Anthracite coloured



RCY120C

Potenza - Power	1.200 W
Voltaggio - Voltage	230V 50/60 Hz
Peso netto - Net weight	650 gr.
Colore - Colour	Bianco White

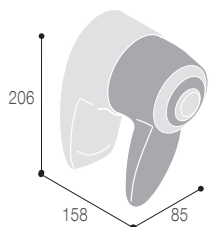

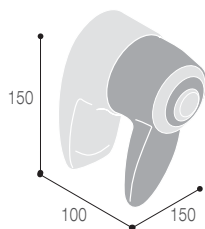

M-1288

Potenza - Power	1.200 W
Voltaggio - Voltage	230V 50/60 Hz
Peso netto - Net weight	700 gr.
Colore - Colour	Bianco White

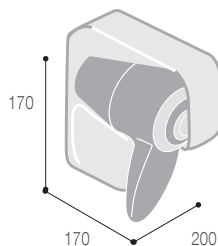

M-1288B

Potenza - Power	1.200 W
Voltaggio - Voltage	230V 50/60 Hz
Peso netto - Net weight	800 gr.
Colore - Colour	Bianco White
Presa rasoio - Shaver socket	

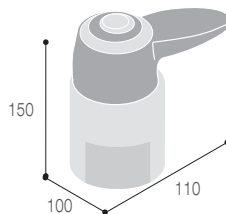

M-1288C

Potenza - Power	1.200 W
Voltaggio - Voltage	230V 50/60 Hz
Peso netto - Net weight	850 gr.
Colore - Colour	Bianco White
Presa rasoio - Shaver socket	

Condizioni generali di vendita

Ordini

Si invita la Spett.le Clientela ad inviare ordini solamente in forma scritta specificando chiaramente quanto segue:

- ragione sociale ed indirizzo completi di telefono, fax, e-mail;
- descrizione e codice prodotti;
- quantità;
- tipo di alimentazione;
- termini di consegna richiesti;
- vettore e modalità di consegna.

I Clienti che ci contattano per la prima fornitura dovranno indicare numero di Partita IVA e le coordinate bancarie (BBAN/ IBAN).

Pagamenti

La prima fornitura di merce considera il seguente pagamento:

- contrassegno vettore;
- bonifico bancario anticipato;
- pagamento garantito a mezzo fidejussione bancaria o garanzia accettata dalla Vitrifrigo.

Le forniture successive considereranno i pagamenti concordati con la rete vendita ed accettati dalla Vitrifrigo.

Per ordinativi di merce con importo netto inferiore a € 250,00 Vitrifrigo richiederà pagamento in contrassegno.

Per ordinativi di merce con importo netto inferiore a € 500,00 Vitrifrigo richiederà forma di pagamento in un'unica soluzione.

Le spese riferite si intendono sempre a carico dell'acquirente.

Ritardi o irregolarità di pagamento daranno facoltà a Vitrifrigo di sospendere qualunque fornitura ed annullare contratti in essere applicando gli interessi di mora nei termini di legge vigenti.

Spedizioni

Le spedizioni delle merci in ordine si intendono sempre Franco Fabbrica e le merci viaggiano a rischio e responsabilità dell'acquirente.

Il destinatario deve :

- verificare eventuali danneggiamenti causati dal trasporto indicando eventuali riserve nella bolla di consegna;
- segnalare eventuali reclami in forma scritta entro 8 gg dal ricevimento della merce.

Vitfrigo declina ogni responsabilità per ritardi di consegna imputabili ai vettori.

Se non espressamente indicato dall'acquirente il Vettore verrà incaricato dalla Vitrifrigo.

Resi di materiali

Si accettano resi solo se preventivamente autorizzati da responsabili Vitrifrigo.

Gli stessi viaggiano a rischio e responsabilità dell'acquirente.

In caso di guasti o difetti di funzionamento contattare l'ufficio Service Vitrifrigo o un ns. Centro Assistenza Tecnica autorizzato.

Ricambi

Gli ordini relativi ai ricambi prevedono un importo minimo fatturabile di € 85 e l'aggiunta di € 15 (spese di gestione) per ordini di importo inferiore, escluse le spese di trasporto.

Foro competente

Per qualsiasi controversia, il foro competente è quello di Pesaro.

Vitfrigo si riserva il diritto di inserire in qualsiasi momento, e senza obbligo di preavviso, tutte le modifiche considerate opportune per ragioni tecniche o commerciali.

Orders.

We invite customers to send orders in writing only, specifying the following:

- full company name and address, telephone, fax and e-mail
- product description and code number
- quantity
- power supply type
- required delivery terms
- carrier and delivery type

Customers contacting us for first-time orders must indicate their VAT registration number and bank account details (BBAN/IBAN).

Payment.

First-time orders must be paid for as follows:

- cash on delivery
- advance bank transfer
- payment guaranteed by bank surety or by some other form of guarantee acceptable to Vitrifrigo.

Subsequent orders can be paid for as agreed with the sales network and accepted by Vitrifrigo.

For orders of goods where the net total is less than € 250.00, Vitrifrigo requires COD payment.

For orders of goods where the net total is less than € 500.00, Vitrifrigo will require payment in full.

Any bank charges named shall be met by the customer. Any arrears or irregularities in payments will entitle Vitrifrigo to suspend any supplies and to cancel any existing contracts with the application of interest on delayed payments in compliance with the laws in force.

Shipment.

Shipment of ordered goods is always Ex Works and goods travel at the exclusive risk and liability of the purchaser.

The intended recipient shall:

- check goods to ensure they comply with the order
- check for any damage that may have occurred during transport, indicating any reservations in the delivery note
- send any complaints in writing no later than 8 days from the receipt of goods.

Vitrifrigo refuses to accept any liability for delays in delivery that can be attributed to the carrier.

Unless otherwise expressly named by the purchase, carriers will be appointed by Vitrifrigo.

Returns.

Returns will not be accepted without the prior authorisation of a Vitrifrigo official. Returned goods travel at the risk and liability of the purchaser. In the event of breakdowns or operating defects, contact the Service Division at Vitrifrigo or one of our authorised Technical Assistance Service Centres.

Spare parts.

We add a € 15 management fee to orders of spare parts under € 85. P&P is excluded.

Competent Court.

Any disputes will be regulated by the Court of Pesaro.

Vitrifrigo reserves the right to make any changes it deems fit for technical or business purposes at any time and with no prior warning.

VITRIFRIGO

COOL AND BEYOND



Vitrifrigo S.r.l.

Via Mazzini, 75 - Frazione Montecchio - 61022 Vallefoglia (PU) - Italy

Tel. +39 0721 154.500 - www.vitrifrigo.com - info@vitrifrigo.com