

Café Collection



CN 57

È il prodotto top della nostra produzione di vetrine brioche da banco. Particolarmente adatta ad ambienti ricercati ed ovunque si voglia il massimo.

The top product from our range of café countertop displays for croissants and pastries. Particularly suited to refined environments and wherever the very best is required.

C'est le produit haut de gamme de notre fabrication de vitrines de comptoir pour viennoiseries. Elle est particulièrement indiquée pour les lieux raffinés et nécessitant les meilleures performances.



CNN573



mm 575 x 340 x 610



°C
+65 / +42

CNR573



mm 575 x 340 x 610

CN60PRF



PIANO REFRIGERATO (OPTIONAL)
COOLED SHELF
TABLETTE RÉFRIGÉRÉE

ETN23



RILEVAMENTO T. SU PIASTRA (soluzione -23°C)
TEMPERATURE TAKEN ON PACK (compound -23°)

TIME	1 h	2 h	3 h	4 h	5 h
TEMP. °C	-4,2	-2,8	-1,9	-1	0

mm 380 x 215 x 25

COLORS





CNR 87 Riscaldata



°C
+65 / +42

CNR87



mm 870 x 510 x 930



°C
+65

CNR87C



mm 870 x 510 x 385

COLORS





Victory

La linea Victory rappresenta la storia della nostra azienda. È la vetrina brioche che ha rivoluzionato la presentazione dei prodotti per la prima colazione ed ha aggraziato con la propria bellezza gran parte dei bar italiani.

The Victory line represents the history of our company. It is the croissant and pastry display that has truly revolutionised the way breakfast products are presented, and has graced with its elegance most of Italy's cafes.

La ligne Victory représente l'histoire de notre société. Cette vitrine pour viennoiseries a été une révolution dans la présentation des produits pour le petit déjeuner et a apporté sa touche de beauté à de très nombreux bars italiens.



 VN3520L

mm 350 x 350 x 390

 VN352NS

mm 350 x 350 x 390

 VN5420L

mm 540 x 350 x 390

 VN542NS

mm 540 x 350 x 390

 VN7420L

mm 740 x 350 x 390

 VN742NS

mm 740 x 350 x 390



 VN3530L

mm 350 x 350 x 550

 VN353NS

mm 350 x 350 x 550

 VN5430L

mm 540 x 350 x 550

 VN543NS

mm 540 x 350 x 550

 VN7430L

mm 740 x 350 x 550

 VN743NS

mm 740 x 350 x 550

COLORS





Victory Riscaldata



°C
+65 / +50

 VR5420L

mm 540 x 350 x 465

 VR542NS

mm 540 x 350 x 465

 VR7420L

mm 740 x 350 x 465

 VR742NS

mm 740 x 350 x 465



°C
+65 / +42

 VR5430L

mm 540 x 350 x 623

 VR543NS

mm 540 x 350 x 623

 VR7430L

mm 740 x 350 x 623

 VR743NS

mm 740 x 350 x 623

COLORS





Victory Cupola



°C
+65

 VN54COL

mm 540 x 350 x 258

 VN54CNS

mm 540 x 350 x 258

 VR54COL

mm 540 x 350 x 334

 VR54CNS

mm 540 x 350 x 334

 VN74COL

mm 740 x 350 x 258

 VN74CNS

mm 740 x 350 x 258

 VR74COL

mm 740 x 350 x 334

 VR74CNS

mm 740 x 350 x 334

COLORS



Rondò 35

EXPO
professional



 PR3520L

mm 350 x 350 x 400

 PR352NS

mm 350 x 350 x 400



 PR3530L

mm 350 x 350 x 560

 PR353NS

mm 350 x 350 x 560

COLORS



MO2





Serie Q



■ QN542

mm 540 x 350 x 390

■ QN742

mm 740 x 350 x 390



■ QN543

mm 540 x 350 x 550

■ QN743

mm 740 x 350 x 550



■ QR542

mm 540 x 350 x 465

■ QR742

mm 740 x 350 x 465



■ QR543

mm 540 x 350 x 623

■ QR743

mm 740 x 350 x 623

COLORS



M03

Serie Q



■ QN54C

mm 540 x 350 x 258

■ QR54C

mm 540 x 350 x 334

■ QN74C

mm 740 x 350 x 258

■ QR74C

mm 740 x 350 x 334



■ QP352

mm 350 x 350 x 400

■ QP353

mm 350 x 350 x 560

COLORS





Espositori con Piastre Eutettiche

Espositori refrigerati con piastre eutettiche studiati e realizzati per l'utilizzo a buffet sono spesso impiegati per l'esposizione ed il servizio dei dolci nella ristorazione tradizionale.

Refrigerated showcases with eutectic plates designed and manufactured for use in buffet services are often used for the display and service of desserts in traditional restaurants.

Des présentoirs à plaques eutectiques conçus et réalisés pour une utilisation en buffet sont souvent utilisés pour la présentation et le service de desserts dans la restauration traditionnelle.



CNE58

MODELLO CON 1 PIASTRA EUTETTICA
Model with 1 eutectic plate



mm 580 x 365 x 220



CNE87

MODELLO CON 3 PIASTRE EUTETTICHE
Model with 3 eutectic plates



mm 870 x 525 x 250

ETN23



RILEVAMENTO T. SU PIASTRA (soluzione -23°C)
TEMPERATURE TAKEN ON PACK (compound -23°)

TIME	1 h	2 h	3 h	4 h	5 h
TEMP. °C	-4,2	-2,8	-1,9	-1	0

mm 380 x 215 x 25

COLORS





Bottle display

Un oggetto dal design accattivante e moderno studiato per rendere più ordinata e pratica l'esposizione delle bottiglie. L'illuminazione a led posta su ogni piano consente la massima visibilità delle etichette ed un eccezionale effetto scenico.

An item with an attractive and modern design, created to display your bottles in a more practical and neat way. The LED lighting system on each shelf gives great visibility to your labels and a unique visual effect.

Un produit beau et actuel, pour une présentation des bouteilles plus ordonnée et plus pratique. L'éclairage à LED sur chaque tablette permet la plus grande visibilité des étiquettes et un effet particulièrement spectaculaire.



BG3

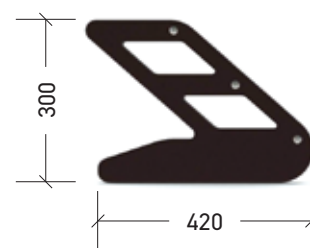

BG4

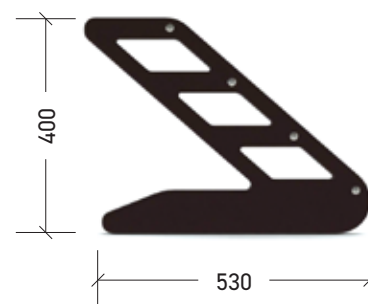

Larghezza standard cm 50 - 100 - 150 - 200
Standard width cm 50 - 100 - 150 - 200

COLORS



Café collection

Sezione dedicata ai prodotti da banco, neutri, riscaldati e refrigerati destinati principalmente a bar e caffetterie.

Le resistenze sono in tubo corazzato mentre la refrigerazione dei buffet è ottenuta con piastre eutettiche con soluzione -23 °C.

Le superfici trasparenti sono realizzate per la gran parte in vetro temperato, mentre i piani di appoggio e le vasche delle versioni riscaldate in alluminio anodizzato.

Section for our countertop products – warm, refrigerated and neutral – aimed at cafés and coffee shops.

The resistors are in armored hose, while refrigerated buffets employ eutectic plates with -23°C solution.

Transparent surfaces are mostly made in tempered glass, while support surfaces and tanks of warm models are made in anodized aluminum.

Section dédiée aux vitrines à poser sur un comptoir, modèles neutres, chauffants et réfrigérés destinés surtout aux cafeterias.

Les résistances sont en tube blindé tandis que la réfrigération est obtenue avec des plaques eutectiques avec solution -23 ° C.

Les surfaces transparentes sont principalement faites en verre trempé et les surfaces de support et les cuves des modèles chauffants sont en aluminium anodisé.

VETRINE BUFFET



1. Cupola in plexiglass
2. Frontalino in legno
3. Piano in alluminio
4. Vasca coibentata

1. Dome in Plexiglas
2. Front plate in wood
3. Plate in aluminum
4. Insulated tank

1. Coupole en plexiglas
2. Panneau frontal en bois
3. Plateau en aluminium
4. Cuve isolé

CNR 57 / 87

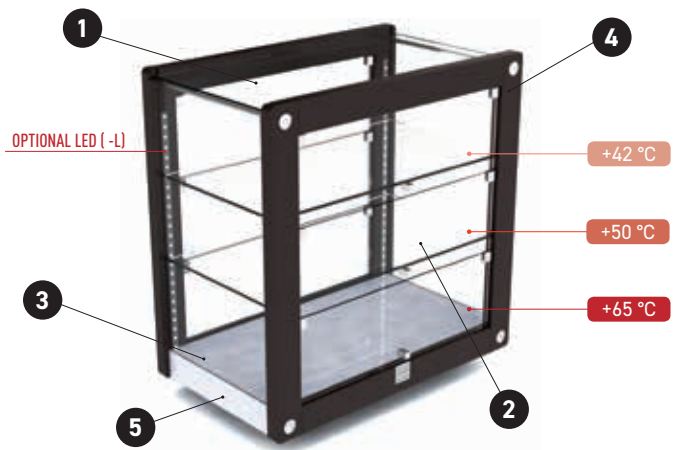

1. Spalle, top e piani in vetro temperato
2. Sportello basculante in vetro
3. Base in alluminio
4. Cornice in MDF
5. Termoregolatore digitale

1. Tempered glass shoulders, top and shelves
2. Pivoting glass door
3. Aluminium base
4. MDF wood frame
5. Digital temperature controller

1. Côtés, dessus et tablettes en verre trempé
2. Porte basculante en verre
3. Base en aluminium
4. Cadre en MDF
5. Régulateur de température numérique

VICTORY / SERIE Q

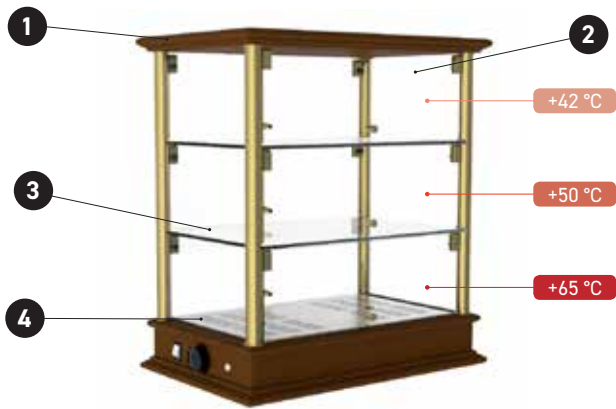

1. Base e top in legno MDF
2. Sportello basculante in vetro
3. Piano estraibile in vetro temperato
4. Interni in alluminio

*1. MDF wooden base and top
2. Pivoting glass door
3. Tempered glass pull-out shelf
4. Aluminium interior*

*1. Base et dessus en MDF
2. Porte basculante en verre
3. Tablette amovible en verre trempé
4. Intérieurs en aluminium*

CUPOLA

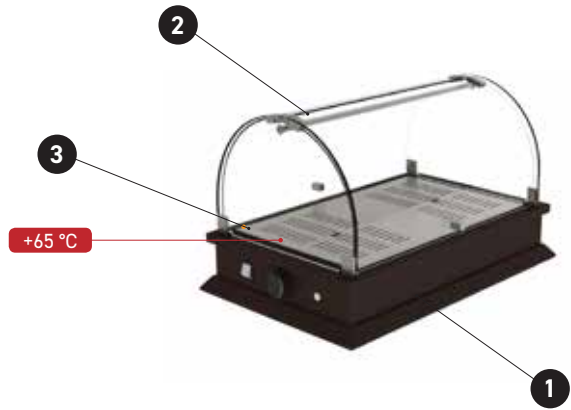

1. Base in legno MDF
2. Cupola in plexiglass
3. Interni in alluminio

*1. MDF wooden base
2. Plexiglass dome
3. Aluminium interior*

*1. Base en MDF
2. Coupole en plexiglas
3. Intérieurs en aluminium*

PORTATORTE

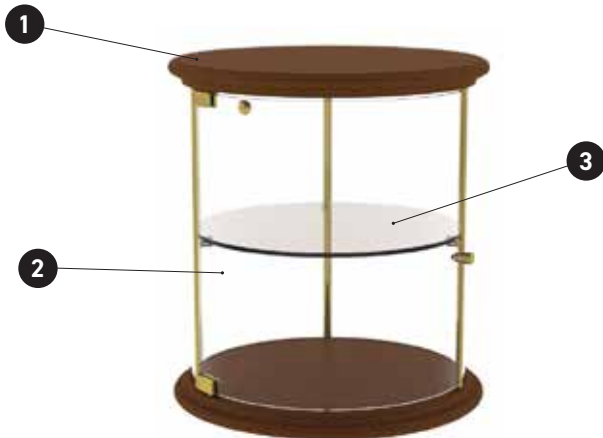

1. Base e top in legno MDF
2. Spalle e sportelli in plexiglass
3. Piano estraibile in vetro temperato

*1. MDF wooden base and top
2. Plexiglass shoulders and doors
3. Tempered glass pull-out shelf*

*1. Base et dessus en MDF
2. Côtés et portes en plexiglas
3. Tablette amovible en verre trempé*

BOTTLE DISPLAY



1. Spalle in MDF laccato
2. Piano in alluminio

*1. Lacquered MDF shoulders
2. Aluminium top*

*1. Côtés en MDF laqué
2. Tablette en aluminium*

HPL laminato alta pressione • high pressure laminate • stratifiés haute pression

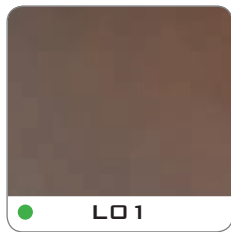

● **LD1**

HPL non verniciato
no finish HPL
HPL non peinte

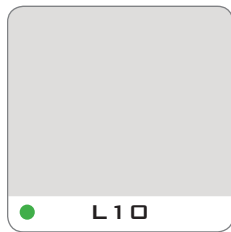

● **L10**

bianco opaco
matt white
blanc mat



● **L11**

nero opaco
matt black
noir mat

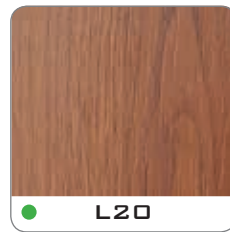

● **L20**

castagno
chestnut
chêne



● **L21**

teak roble
teak roble
teck rouvre



● **L22**

wengé loft
loft wenge
wenge loft



● **L23**

larice cenere
ash Larch
mélèze cendre



● **L40**

cemento tortora
dove concrete
ciment taupe

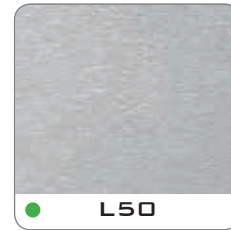

● **L50**

acciaio satinato
satin-finish steel
acier satiné

MDF non verniciato • No finish MDF • MDF non peinte



● **MD1**

MDF non verniciato
no finish MDF
MDF non peinte

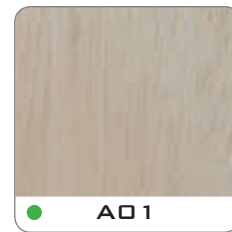

● **AO1**

ayous non verniciato
no finish ayous
ayous non peinte

Rivestimento in foglia • Leaf finish • Revêtement en feuille métallique

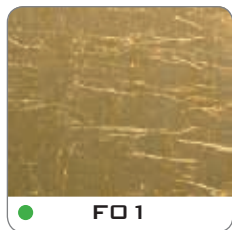

● **FO1**

oro patinato
gold coated
revêtement or



● **FO2**

argento patinato
silver coated
revêtement argent

Verniciatura a liquido • Liquid paint finish • Laquage par peinture liquide

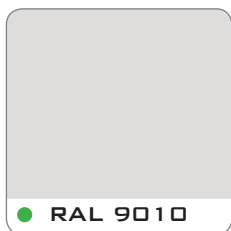

● **RAL 9010**

bianco opaco (20 gloss)
matt white (20 gloss)
blanc mat (20 gloss)

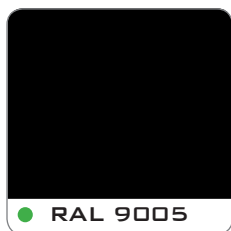

● **RAL 9005**

nero opaco (20 gloss)
matt black (20 gloss)
noir mat (20 gloss)

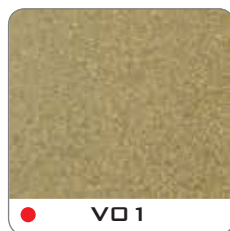

● **VO1**

verniciato oro
gold painted
peinture or



● **VO2**

verniciato argento
silver painted
peinture argent



● **RAL 20/100**

opaco 20 gloss - lucido 100 gloss
matte 20 gloss - polished 100 gloss
mat 20 gloss - brillant 100 gloss

Verniciatura a liquido (Dune) • Liquid paint finish (Dune) • Laquage par peinture liquide (Dune)



● DRAL 9010

bianco opaco (20 gloss)
matt white (20 gloss)
blanc mat (20 gloss)

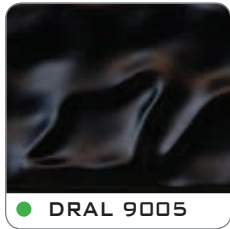

● DRAL 9005

nero opaco (20 gloss)
matt black (20 gloss)
noir mat (20 gloss)



● DVO 1

verniciato oro
gold painted
peinture or



● DVO 2

verniciato argento
silver painted
peinture argent

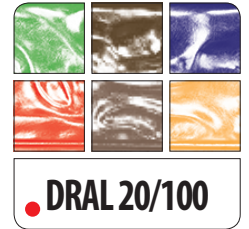

● DRAL 20/100

opaco 20 gloss - lucido 100 gloss
matte 20 gloss - polished 100 gloss
mat 20 gloss - brillant 100 gloss

Dune non verniciato • Dune no finish • Dune non peinte



● DO 1

Dune non verniciato
Dune no finish
Dune non peinte



● DFO 1

oro patinato
gold coated
revêtement or



● DFO 2

argento patinato
silver coated
revêtement argent

Rivestimento in foglia (Dune) • Leaf finish (Dune)

Laminato • Laminate • Stratifié



● T02

grigio monsoone
gray monsoon
gris mousson

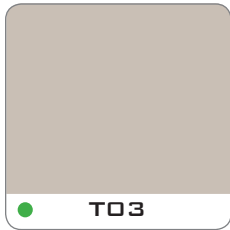

● T03

sabbia creola
creole sand
sable créole



● T04

blu avio
airforce blue
bleu aviation

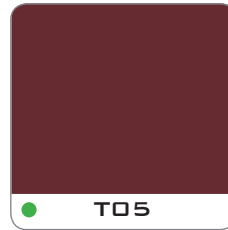

● T05

rosso mattone
red brick
brique



● T20

rame spazzolato
brushed copper
cuivre satiné



● T21

rame acidato
acid washed copper
cuivre traité à l'acide

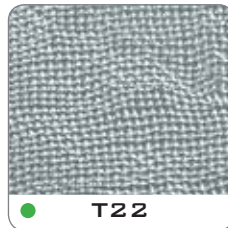

● T22

argento lux
silver lux
argent lux

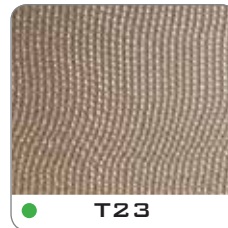

● T23

bronzo lux
bronze lux
bronze lux

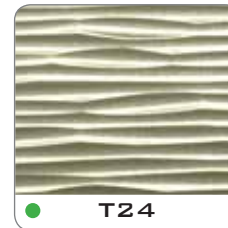

● T24

oro onde
gold wave
vague d'or

● Standard • Standard • Standard

● Su richiesta • On demand • Sur demande

Colorazioni speciali RAL

Special RAL colors

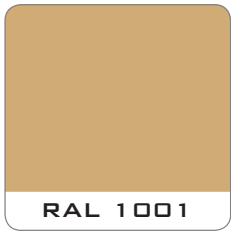

RAL 1001

BEIGE

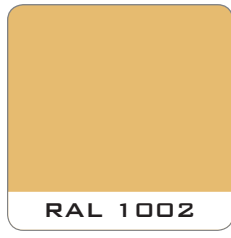

RAL 1002

SAND YELLOW

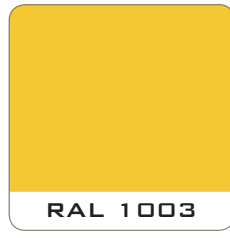

RAL 1003

SIGNAL YELLOW

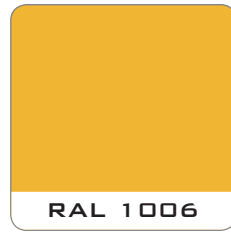

RAL 1006

MAIZE YELLOW

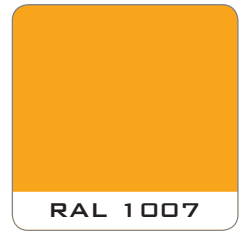

RAL 1007

DAFFODIL YELLOW



RAL 1011

BROWN BEIGE

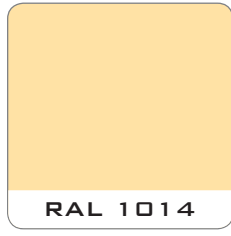

RAL 1014

IVORY



RAL 1015

LIGHT IVORY



RAL 1019

GREY BEIGE



RAL 1024

OCHRE YELLOW

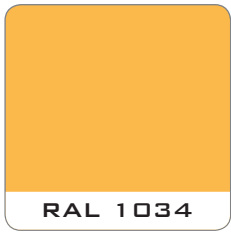

RAL 1034

PASTEL YELLOW



RAL 2000

YELLOW ORANGE



RAL 2003

PASTEL ORANGE



RAL 2010

SIGNAL ORANGE



RAL 3004

PURPLE RED



RAL 3005

WINE RED



RAL 3007

BLACH RED

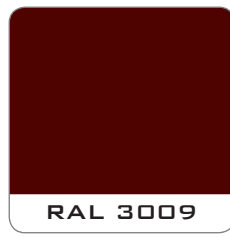

RAL 3009

OXIDE RED



RAL 3012

BEIGE RED



RAL 3017

ROSE



RAL 3031

ORIENT RED



RAL 4001

RED LILAC



RAL 4004

CLARET VIOLET

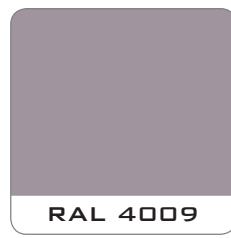

RAL 4009

PASTEL VIOLET



RAL 5003

SAPPHIRE BLUE



RAL 5004

BLACK BLUE



RAL 5005

SIGNAL BLUE



RAL 5008

GREY BLUE



RAL 5012

LIGHT BLUE



RAL 5014

PIGEON BLUE

 RAL 5020 OCEAN BLUE	 RAL 6005 MOSS GREEN	 RAL 6011 RESEDA GREEN	 RAL 6019 PASTEL GREEN	 RAL 7000 SQUIRREL GREY
 RAL 7001 SILVER GREY	 RAL 7003 MOSS GREY	 RAL 7004 SIGNAL GREY	 RAL 7006 BEIGE GREY	 RAL 7011 IRON GREY
 RAL 7030 STONE GREY	 RAL 7032 PEBBLE GREY	 RAL 7035 LIGHT GREY	 RAL 7036 PLATINUM GREY	 RAL 7042 TRAFFIC GREY A
 RAL 8002 SIGNAL BROWN	 RAL 8007 FAWN BROWN	 RAL 8014 SEPIA BROWN	 RAL 8017 CHOCOLATE BROWN	 RAL 8019 GREY BROWN
 RAL 8022 BLACK BROWN	 RAL 8025 PALE BROWN	 RAL 8028 TERRA BROWN	 RAL 9001 CREAM	 RAL 9002 GREY WHITE
 RAL 9003 SIGNAL WHITE	 RAL 9004 SIGNAL BLACK	 RAL 9005 JET BLACK	 RAL 9010 PURE WHITE	 RAL 9016 TRAFFIC WHITE

I colori stampati in questa cartella sono indicativi
The colours printed and shown in this folder are merely indicative
Les coloris imprimés ici sont indicatifs

Legenda





























LEGEND



LÉGENDE



CODE	Codice	Code	Code
	Temperatura (Temperatura ambiente 25 °C - Umidità relativa 50%)	Temperature (Ambient temperature 25°C - Relative humidity 50%)	Température (Température ambiante 25°C - Humidité relative 50%)
	Umidità (Temperatura ambiente 25 °C - Umidità relativa 50%)	Humidity (Ambient temperature 25°C - Relative humidity 50%)	Humidité (Température ambiante 25°C - Humidité relative 50%)
	Versione	Versio n	Version
	Refrigerato	Cooled	Réfrigéré
	Neutro	Neutral	Neutre
	Piastr e eutettiche	Eutectic plates	Plaques eutectiques
	Riscaldato	Heated	Chauffant
	Ventilato	Ventilated	Ventilé
	Ventole interne spente	Internal fans off	Ventilation interne désactivée
	Ventole interne accese	Internal fans on	Ventilation interne activée
	Rumorosità	Noise level	Bruyance
	Tensione	Voltage	Tension
	Assorbimento	Absorption	Absorption
Class	Classe energetica	Energy class	Classe énergétique
	Modello compressore	Compressor type	Modèle du compresseur
HFC	Gas refrigerante	Refrigerant gas	Gaz réfrigérant
	Quantità gas	Gas amount	Quantité de gaz
	Numero piastre eutettiche	Number of eutectic plates	Nombre de plaques eutectiques
LIGHT	Luce	Light	Lumière
	Led bianco naturale (4000 K - 30 led/mt - 7,2 W / mt - 572 lumen / mt)	White natural daylight LED (4000 K - 30 led/mt - 7,2 W / mt - 572 lumen / mt)	LED blanc day-light naturel (4000 K - 30 led/mt - 7,2 W / mt - 572 lumen / mt)
	Led bianco caldo (3000 K - 60 led/mt - 14,4 W / mt - 900 lumen / mt)	brightwhite warm LED (3000 K - 60 led/mt - 14,4 W / mt - 900 lumen / mt)	LED blanc chaud (3000 K - 60 led/mt - 14,4 W / mt - 900 lumen / mt)
	Led blu	Blue LED	LED bleue
	Controller RGB (30 led/mt - 7,2 W / mt - 550 lumen / mt)	RGB controller (30 led/mt - 7,2 W / mt - 550 lumen / mt)	Regulateur RGB (30 led/mt - 7,2 W / mt - 550 lumen / mt)
	Controller bianco dinamico (2700/6000 K - 140 led/mt - 19,2 W / mt - 2000 lumen / mt)	Dinamic white controller (2700/6000 K - 140 led/mt - 19,2 W / mt - 2000 lumen / mt)	Regulateur blanc dynamique (2700/6000 K - 140 led/mt - 19,2 W / mt - 2000 lumen / mt)
	Cornice lineare	Linear frame	Cadre linéaire
	Cornice Dune	Dune frame	Cadre Dune

	Finitura metallo	Metal finish	Finition métal
	Nikel satinato	Satin nickel	Nickel satiné
	Oro lucido	Glossy gold	Doré brillant
	Lato posteriore vetrina	Showcase back side	Face postérieure vitrine
	Ante in vetro	Glass doors	Porte en verre
	Pannello cieco	Blank panel	Panneau borgne
	Numero piani (base compresa)	Number of shelves (including base)	Nombre de tablettes (base comprise)
	Numero cassetti	Number of drawers	Nombre de tiroirs
	Numero ante	Number of doors	Nombre de portes
	Numero bottiglie	Number of bottles	Nombre de bouteilles
	Altezza / diametro bottiglie	Bottle height / diameter	Hauteur/ diamètre bouteilles
	Kit salumeria	Salami kit	Kit salaisons
	Colore spalla	Shoulder colour	Coloris côté
	Presente	Present	Présent
-	Assente / dato non disponibile	Absent / data not available	Absent / information non disponible
	Volume interno	Internal volume	Capacité intérieure
	Dimensioni nette	Net dimensions	Dimensions nettes
	Dimensioni con imballo	Dimensions including packaging	Dimensions avec emballage
	Dimensioni con imballo su pedana	Dimensions including packaging on pallet	Dimensions avec emballage sur palette
	Peso netto	Net weight	Poids net
	Peso con imballo	Weight with packaging	Poids avec emballage
	Peso con imballo su pedana	Weight with packaging on pallet	Poids avec emballage sur palette
	Volume con imballo	Volume with packaging	Volume avec emballage
	Volume con imballo su pedana	Volume with packaging on pallet	Volume avec emballage sur palette
	Imballo in legno	Wooden packaging	Emballage en bois
DS	Descrizione	Description	Description
	Dimensione ventola	Fan blade size	Dimension du ventilateur
	∅ mm - Connesioni (liquido - aspirazione)	∅ mm - Connections (liquid - suction)	∅ mm - Connexions (liquide - aspiration)